

Item	Spare parts	Q'ty
1	NUT ϕ 5/16"-18UNC ---8pcs	2
2	WASHER ϕ 8* ϕ 16 ---28pcs	2
3	SPRING WASHER ϕ 5/16" ---8pcs	2
4	SCREW BH 5/16"-18UNC*L2 1/2" ---8pcs	2
5	PLASTIC COVER ϕ 25.4 ---4pcs	2
6	SCREW 1/4"-20UNC*L50mm ---6pcs	2
7	SCREW 1/4"-20UNC*L 1/2" ---6pcs	2
8	SCREW M8*P1.25*L15mm ---12pcs	2
9	FIXED PLATE	12
10	ADJUSTMENT GROUP A	2
11	ADJUSTMENT GROUP B	2

The knob can adjust fixed plate the distance of the level of vertical roughly 18mm, as well as adjustable tilt 0.5°

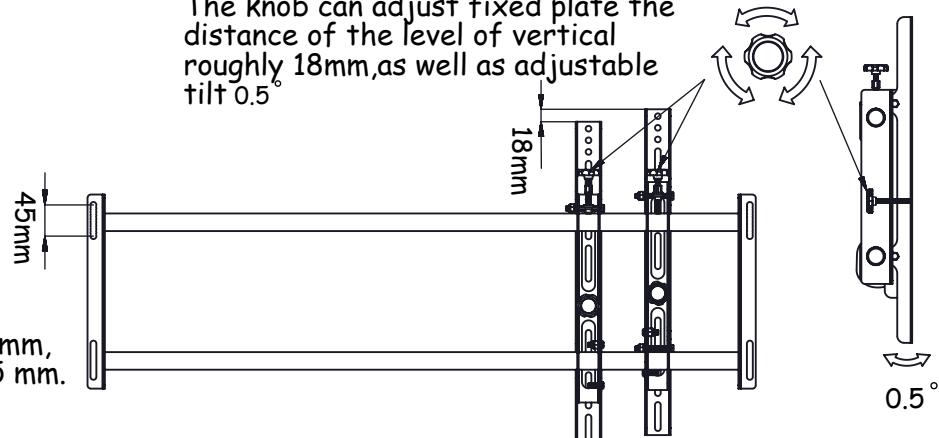

Adjustable up / down of 45mm, each fine-tune the pitch of 5 mm.

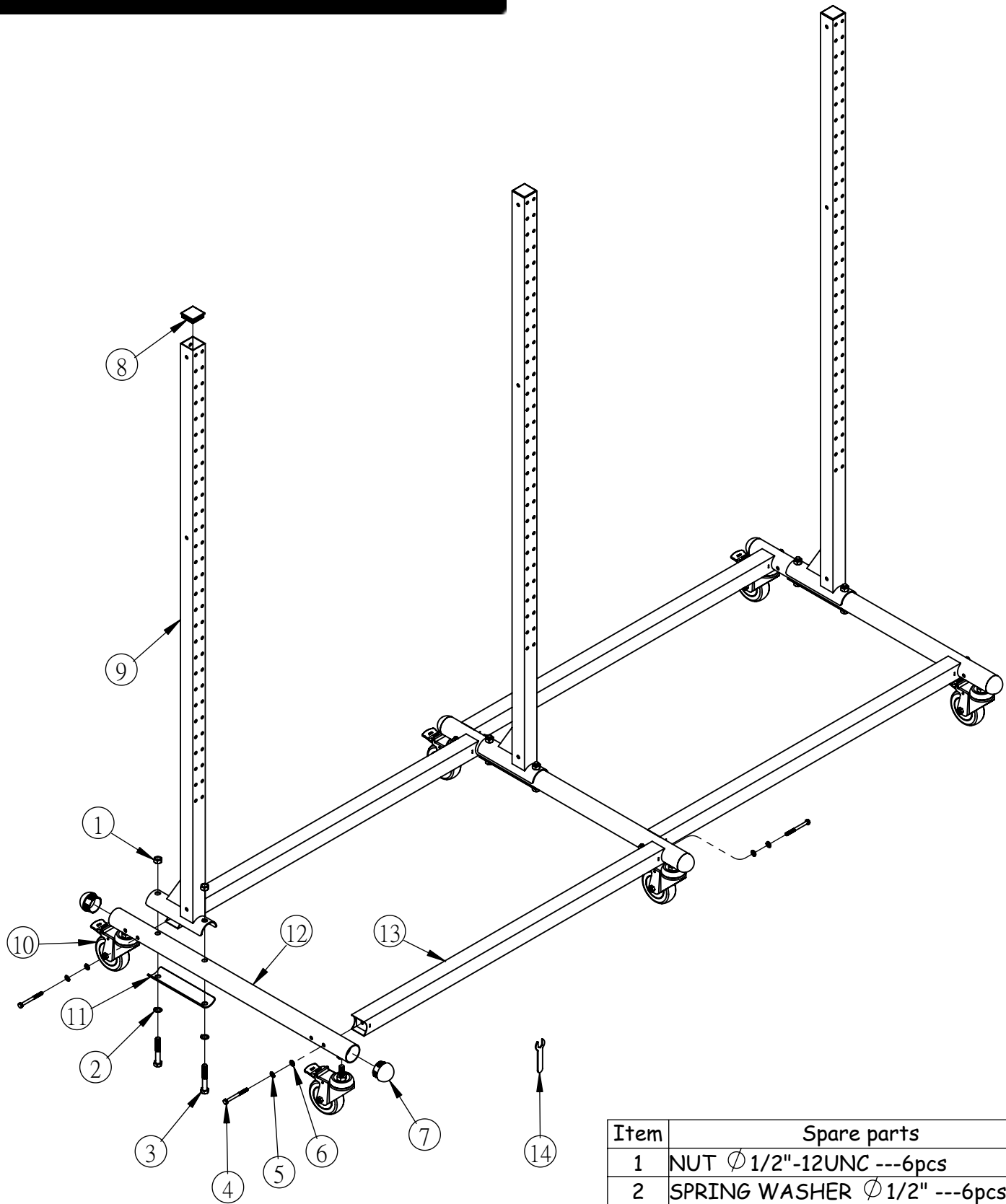

Item	Spare parts	Q'ty
1	NUT ϕ 1/2"-12UNC ---6pcs	1
2	SPRING WASHER ϕ 1/2" ---6pcs	1
3	SCREW BH 1/2"-12UNC*L3" ---6pcs	1
4	SCREW BH 5/16"-18UNC*L3" ---8pcs	1
5	SPRING WASHER ϕ 5/16" ---8pcs	1
6	WASHER ϕ 8* ϕ 16 ---8pcs	8
7	PLASTIC COVER ϕ 50.8 ---6pcs	1
8	PLASTIC COVER \square 45*45 ---3pcs	1
9	FIXED TUBE	3
10	WHEEL	6
11	U PLATE	3
12	BASE TUBE	3
13	SQUARE TUBE	4
14	WRENCH NO.21	1